

SPECS

PEAVEY ELECTRONICS

Impulse™ 500 Sub

Add-On Weather-Resistant Injection-Molded Subwoofer Speaker System

SPECIFICATIONS

Enclosure:

Peavey Impulse™ 500 Subwoofer

Frequency Response:

Filtered:

50 Hz to 150 Hz

Unfiltered:

50 Hz to 2.8 kHz

Low Frequency Limit (-3 dB point):

50 Hz

Useable Low Frequency Limit (-10 dB point):

44 Hz

Power Handling:

Filtered:

300 W continuous (34.6 V RMS)

600 W program

1,200 W peak

Unfiltered:

350 W continuous (37.4 V RMS)

700 W program

1,400 W peak

Sound Pressure Level (1W @ 1m, swept-sine input in anechoic environment):

Filtered:

98 dB

Unfiltered:

101 dB (midrange level)

Maximum Sound Pressure Level:

Filtered:

119 dB continuous



Unfiltered:

122 dB continuous

Unfiltered:

1/4" phone jack

Transducer Compliment:

Model 1554 15" Black Widow® woofer

Box Tuning Frequency (Fbox):

44 Hz

Crossover Type:

Passive Internal Low Pass

Electroacoustic Crossover Frequency (Filtered):

150 Hz

Crossover Slope:

12 dB/octave (2nd order) low pass

Impedance (Nominal):

4 ohms

Impedance (Minimum):

3.0 ohms

Input Connections:

Filtered:

1/4" phone jack and 4-pin Neutrik® Speakon® connector in parallel

Enclosure Materials and Finish:

Injection-molded high-impact polypropylene of a nominal thickness of 1/4" and with textured finish

Mounting:

Stand mounting via molded-in mount, flying via Versamount™ 70 (top or bottom of cabinet) and four rubber feet for floor use

Dimensions (H x W x D):

28.562" tall x 21.312" wide (11.5" wide in rear) x 17" deep. [72.55 cm x 54.13 cm (29.21 cm rear) x 43.18 cm]

Net Weight: 52 lbs.

Shipping Weight: 59 lbs. (EST.)



Additional Remarks:

Specifications for Impulse 500 and the Impulse 500 Subwoofer system, subwoofer used in add-on mode via filtered input

Frequency Response:

42 Hz to 18 kHz

Low Frequency Limit (-3 dB point):

42 Hz

Useable Low Frequency Limit (-10 dB point):

37 Hz

Power Handling (System now 2.7 ohm):

450 W continuous (34.6 V RMS)

900 W program

1,800 W peak

Impedance, Nominal:

2.7 ohms

Impedance, Minimum:

2.3 ohms

Features:

- 350 W continuous, unfiltered input
- HyperVent™ plus direct radiator design
- Add-On Subwoofer with easy hookup
- 15" Black Widow 4 ohms woofer
- Compact, lightweight
- Low pass filtered input, unfiltered direct input
- Built-in carry handles
- Mounting points top and bottom
- Stand mount built-in

DESCRIPTION

The Impulse 500 Subwoofer is designed to be an add-on subwoofer for the Impulse 500 or the Impulse 200 full range speaker system. Simply run the normal full range signal to the Impulse 500, then run either a 1/4" phone jack terminated cable, or a four pin Neutrik terminated cable out from the second jack on the Impulse 500 full range speaker system over to the Impulse 500 Subwoofer, and jack into the "FILTERED INPUT" on the subwoofer. The ease and flexibility of adding on a subwoofer has never been easier! The system with both the Impulse 500 full range system and Impulse 500

Subwoofer is now a 2.7 ohm composite system, with a power handling of 450 watts (34.6 V RMS). Bass response has been extended to approx. 42 Hz, and the tonal balance of the composite system has been warmed up to the point where no bass boost is required.

For biamplification use with an electronic crossover, just use the unfiltered 1/4" phone input jack. This input is also useful for utilizing the Impulse 500 Subwoofer as a compact, high-output drum monitor.

The Impulse 500 Subwoofer is equipped with a Peavey innovation called the HyperVent. This unique vent reduces the pipe organ resonance of the vent tube and allows a vent to seem longer in one dimension than it physically is. Because the open end of the vent terminated acoustically, standing waves are reduced and the hollow sound of an ordinary vent is avoided. Without these typical vent "sounds" to call attention, the subwoofer is harder to localize and placement is less critical.

The Peavey Impulse 500 Subwoofer has a 15" model 1554 MR Black Widow woofer in it, providing high-power, low bass response in a compact system package.

ARCHITECTURAL AND ENGINEERING SPECIFICATIONS

The loudspeaker system shall have a frequency response from 44 Hz to 150 Hz through the filtered inputs, and from 44 Hz to 2.8 kHz through the unfiltered input. The nominal impedance shall be 4 ohms. The continuous power handling through the filtered input shall be 300 watts, maximum program power of 600 watts and a peak power handling of 1,200 watts, with a minimum amplifier headroom of 3 dB. The peak SPL with inaudible distortion shall reach 119 dB through the filtered input, and 122 dB through the unfiltered input with music as a source, when measured at a distance of 1m and driven to full output capacity. The system shall utilize a 15" Black Widow 1554 MR woofer.

The enclosure shall be constructed of injection-molded polypropylene of 1/4" nominal thickness and with a UL flame rating, and reinforcing ribs internally. A handgrip shall be molded in on each side of the woofer and on the top rear edge. A vinyl coated perforated metal grille shall be provided for woofer protection. The cabinet shall incorporate four, tall, sturdy rubber feet for floor standing use, and four mounting point inserts on the top and bottom each for flying use.

The enclosure shall incorporate a vent of the type known as a HyperVent.

The outside dimensions shall be 28.562" (72.55 cm) tall by 21.312" (54.13 cm) wide (11.5" {29.21 cm} wide in rear) by 17" (43.18 cm) deep and the weight shall be 52 lbs. The loudspeaker system shall be called a Peavey Model Impulse 500 Subwoofer.

Neutrik™ and Speakon™ are registered trademarks of Neutrik AG. Versamount™ is a trademark of Unitrack Industries, Inc.



Warning! When use of a stand is considered, the Peavey S-1™ stand is recommended. Other stands may not have a base sufficiently wide enough for stability and safety.



CAUTION! For permanent outdoor installation, avoid direct cone exposure to sunlight and rain by tilting speaker down and use a splash shield on top.



WARNING! Before attempting to suspend this speaker, consult a certified structural engineer. Speaker can fall from improper suspension, resulting in serious injury and property damage. Do not suspend or mount any other product or device from this enclosure! Use only Grade 5 hardware or better.

Impulse 500 Sub

Amplitude Response (1W 1m On-Axis)

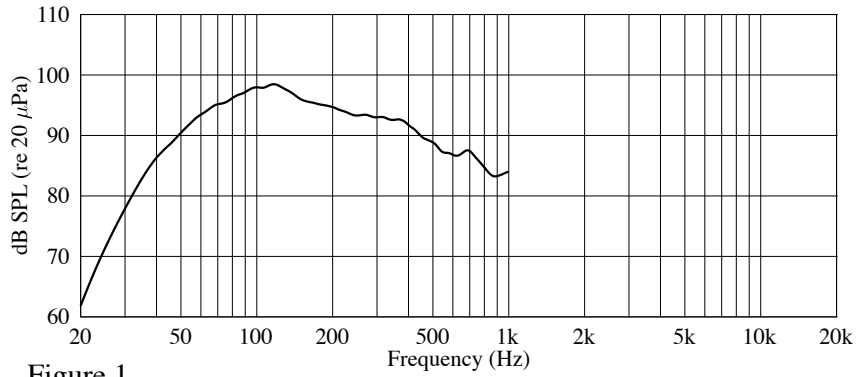

Figure 1

Impedance

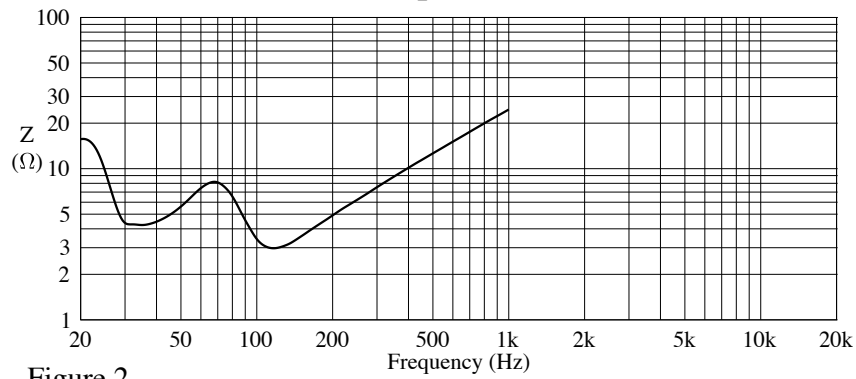

Figure 2

Harmonic Distortion at 1/100 Rated Power

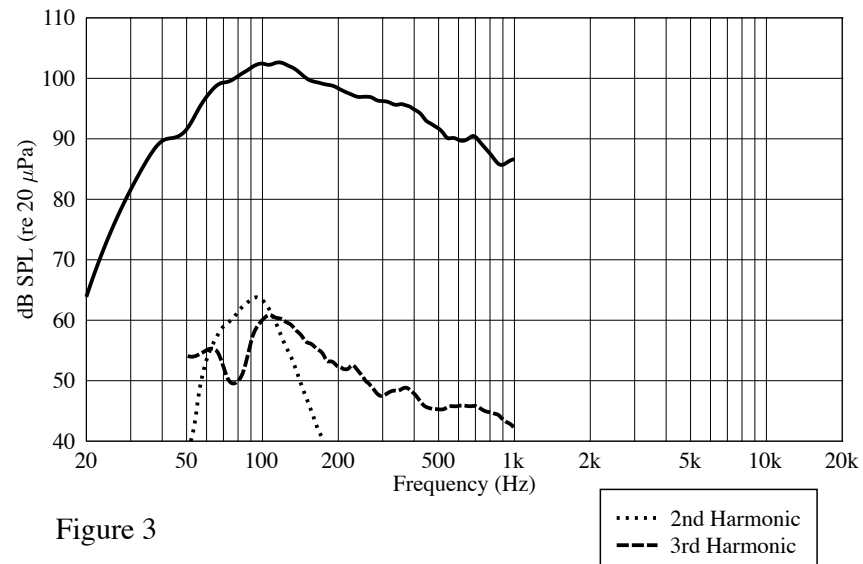

Figure 3

Impulse 500 Sub

Harmonic Distortion at 1/10 Rated Power

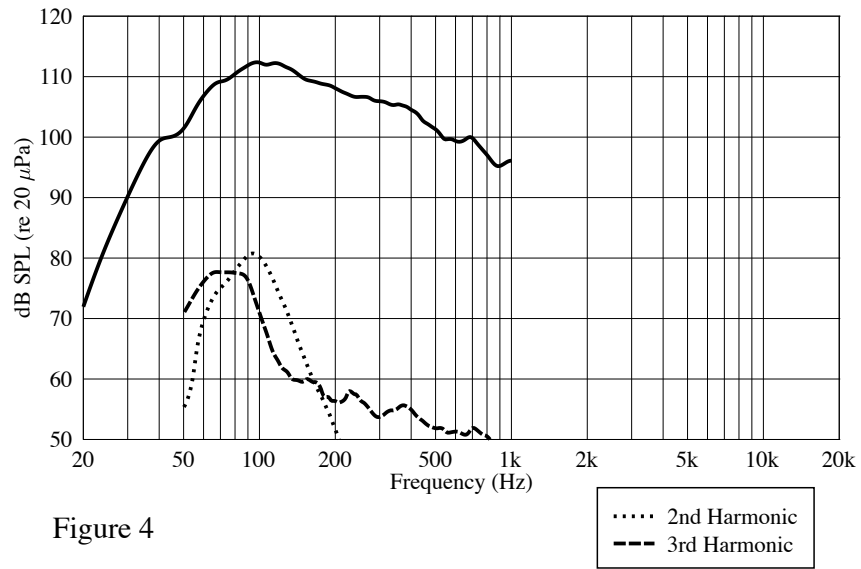

Figure 4

Amplitude Response (1W 1m On-Axis) Impulse 500 and Impulse 500 Sub used together

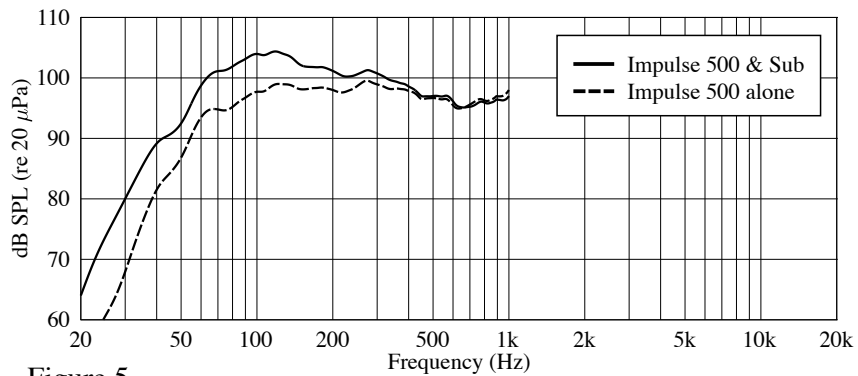

Figure 5

Impedance Impulse 500 and Impulse 500 Sub used together

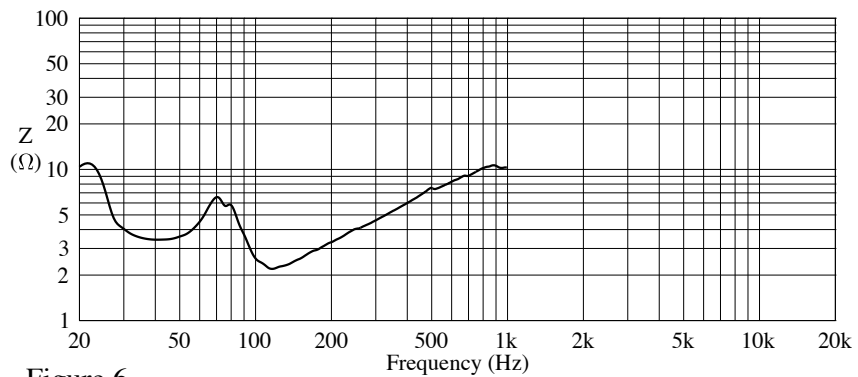
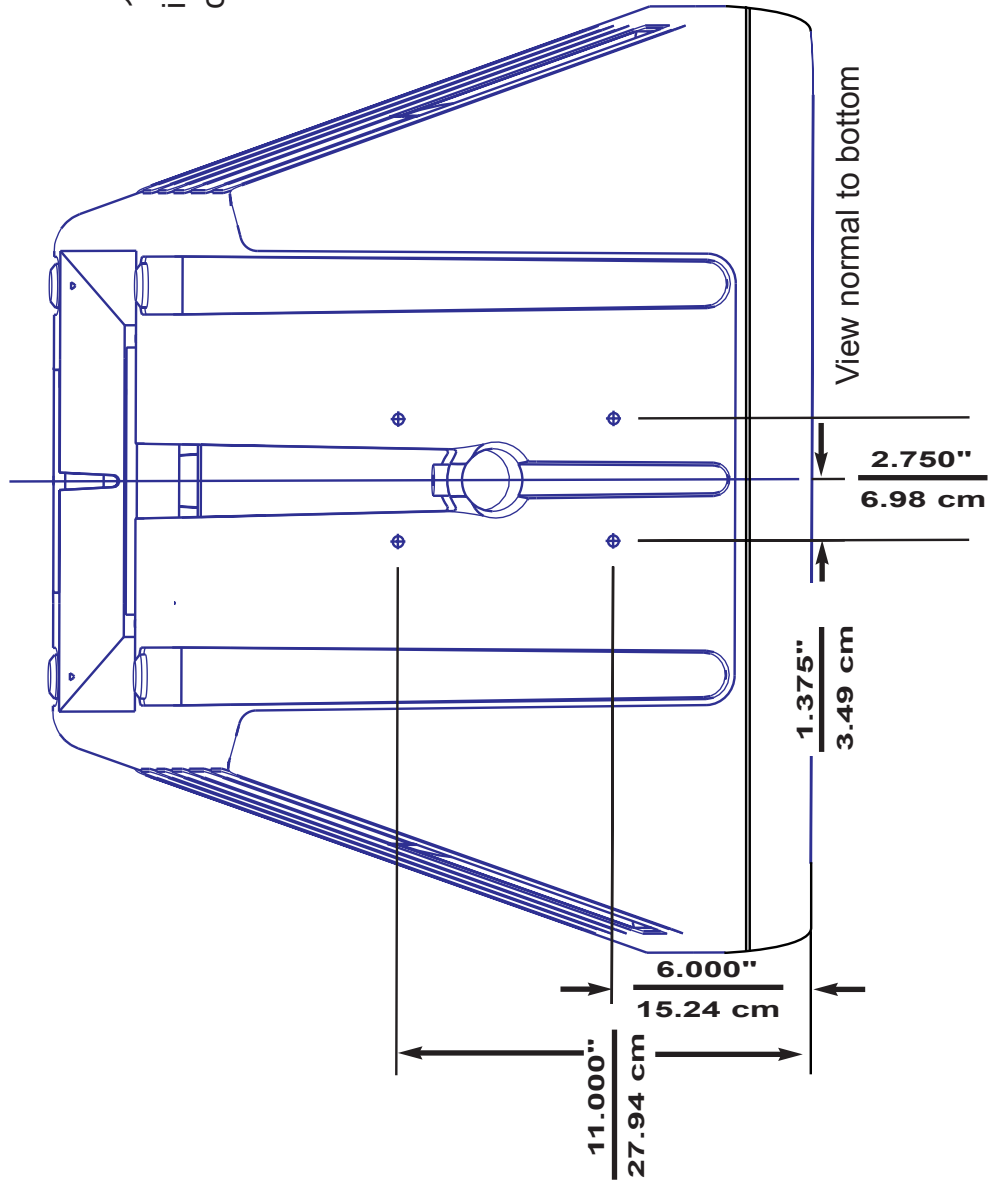

Figure 6

Impulse™ 500 Sub Mounting Dimensions



1/4" -20 x 3/4 full thread
insert four each end of
cabinet same location

THREE + TWO LIMITED WARRANTY

NOTE: For details, refer to the warranty statement. Copies of this statement may be obtained by contacting Peavey Electronics Corporation, P.O. Box 2898, Meridian, Mississippi 39302-2898.

Features and specifications subject to change without notice.

Peavey Electronics Corporation • 711 A Street • Meridian • MS • 39301
(601) 483-5365 • FAX (601) 486-1278 • www.peavey.com

