

OPERATING INSTRUCTIONS



Intended to alert the user to the presence of uninsulated "dangerous voltage" within the product's enclosure that may be of sufficient magnitude to constitute a risk of electric shock to persons.



Intended to alert the user to the presence of important operating and maintenance (servicing) instructions in the literature accompanying the product.

CAUTION: Risks of electrical shock — DO NOT OPEN

CAUTION: To reduce the risk of electric shock, do not remove cover. No user serviceable parts inside. Refer Servicing to qualified service personnel.

UMATM/12T

Utility Mixer Amplifier



PEAVEY[®]

ARCHITECTURAL
ACOUSTICS[®]

WARNING!

DO NOT ATTEMPT TO INSTALL THIS UNIT WHILE IT, OR ANY CONNECTING UNITS, ARE POWERED ON. RISK OF ELECTRICAL SHOCK EXISTS IF ALL UNITS ARE NOT POWERED OFF DURING INSTALLATION. TO PREVENT ELECTRICAL SHOCK OR FIRE HAZARD, DO NOT EXPOSE THIS APPLIANCE TO RAIN OR MOISTURE.

FEATURES:

POWER OUTPUT:

12 watts RMS into 4 ohms

INPUTS:

Dedicated high Z/low Z MIC 1 with screw terminals (balanced or unbalanced input.)
Switchable MIC 2/AUX input with screw terminals for the MIC 2 input and RCA phono jack for AUX input.
Automatic precedence of MIC 1 over MIC 2/AUX (defeatable)

Controls and Indicators:

MIC 1 level control
MIC 2/AUX selector switch
MIC 2/AUX level control
Tone control
"Contour" Switch
Power On LED
Power Switch

OUTPUTS:

4 ohm screw terminal direct output
8 ohm screw terminal balanced output
25V screw terminal balanced output
70V screw terminal balanced output
1 V/600 ohm balanced output

PACKAGE:

Painted steel shelf-top chassis.

DESCRIPTION

The UMA™/12T is a high performance utility mixer amplifier designed to meet the needs of the most demanding fixed installation/sound reinforcement applications. The user-friendly control layout, coupled with state of the art circuit design, assures reliable long-term operation and smooth trouble free installation.

Twenty-five and seventy volt fully isolated line output capability is standard equipment with this unit and it is rack-mountable in the standard 19" rack configuration using optional rack-mount kit. The "slim-line" chassis design occupies only two vertical rack spaces.

FRONT PANEL

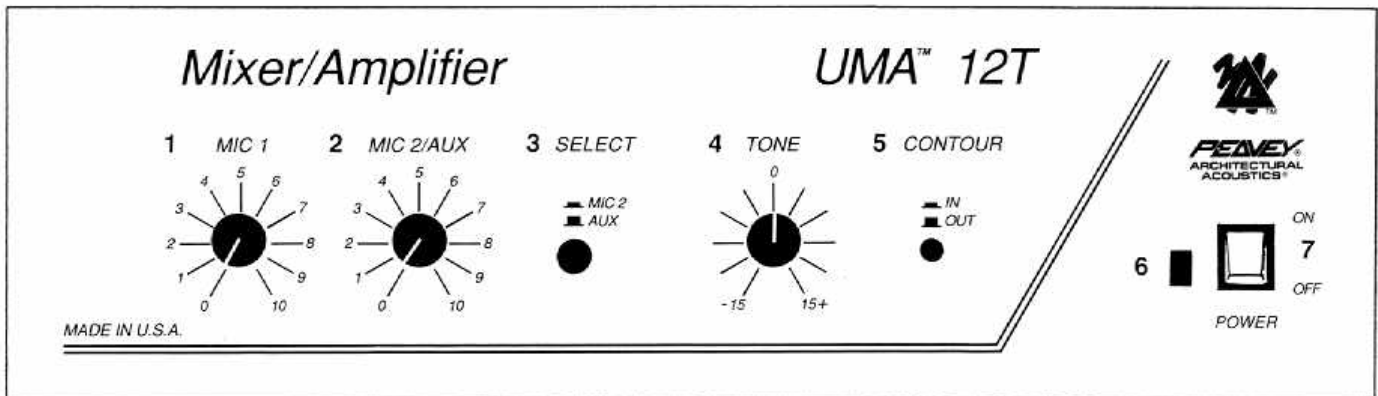

FRONT PANEL CONTROLS:

- MIC 1 Level Control:**
Controls the signal level at the Microphone 1 Input.
- MIC 2/AUX Level Control:**
Controls the signal level at the Microphone 2/AUX Input.
- MIC 2/AUX Select Switch:**
The "in" position of this switch selects the MIC 2 input and the "out" position selects AUX Input.
- Tone:**
Active equalization that provides 12 dB of boost or cut at 10 kHz.
- Contour Switch:**
The "in" position of this switch provides 10 dB boost at 100 Hz and 6 dB boost at 10 kHz. The "out" position removes boost from the system.
- Power LED:**
Indicates when AC power is being supplied to the unit.
- Power Switch:**
Depress to "on" position to turn on.

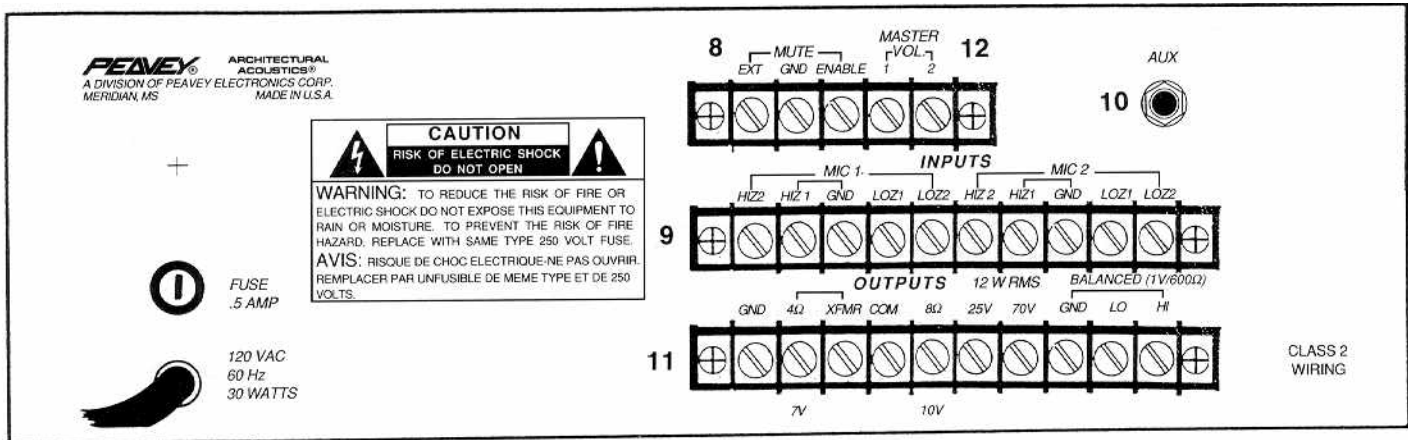

REAR PANEL CONNECTIONS:

8. Mute Control:

These connections allow control over the internal mute control circuitry. To enable muting, connect the GND terminal to the ENABLE terminal. This will allow the MIC 1 signal to mute the MIC 2/AUX channel. Muting of this AUX channel can be selectively disabled internally by moving the two-circuit jumpers on HDR 100 to the position shown by the arrow in Fig. 3. External muting of the MIC 2/AUX channel is also possible by connecting a normally open switch from the GND terminal to the EXT terminal. See Fig. 4.

9. MIC Inputs:

The input connections are configured to allow Low Z, High Z, Balanced, and Unbalanced microphones to be connected to the system. Screw terminals are provided for these connections. See Fig. 6 and 7.

10. Auxiliary inputs:

The AUX input is made through this standard RCA jack. This line input is provided to input any line level signal, such as background music from a tape or tuner output.

11. Outputs:

A direct output, as well as several transformer outputs, are provided to allow the proper interface between the amplifier and the speaker system. The direct output allows direct connection to a 4 ohm speaker system. To use this output, disconnect the jumper between the 4 ohm terminal and the XFMR terminal. Connect the speaker (or speakers) from the GND terminal to the 4 ohm terminal.

8 ohm, 25 volt and 70 volt balanced outputs are also provided. To use these outputs, the jumper between OUT and XFMR must be installed. For 8 ohm speaker systems, connect between the COM terminal and the 8 ohm terminal. 25V and 70V balanced outputs are also provided for "constant voltage" speaker distribution systems. The 25V output connection is between the COM terminal and the 25V terminal. One more output is provided on the UMA Series amplifiers. This is a balanced, transformer isolated line level output. This output is provided for direct connection to "music on hold" systems, booster power amplifiers, etc. This output is designed to deliver 1V RMS into a 600 ohm load. See Fig. 8 through 11 for possible output connections.

12. External Master Volume:

These terminals allow connection of an external volume control. To gain complete control of volume from the external volume control, the front panel Master Volume control must be set to maximum. The external volume control should be connected as shown in Fig. 5.

NOTE: Due to the high gain and frequency response of the UMA Series amplifiers, it is necessary that the input cables be routed away from the output cables to prevent instability. An external shield is provided to aid in the separation of input and output cables and to assure stability under adverse conditions associated with the wide range of applications in which the amplifier might be installed. Under no circumstances should this shield be modified or removed. Care must be taken when connecting cables to the barrier strips to avoid shorting the connections to the shield.

INSTALLATION INFORMATION

POWER AND GROUNDING:

For your safety, we have incorporated a 3-wire line (mains) cable with proper grounding facilities. It is not advisable to remove the ground pin under any circumstances. If it is necessary to use the equipment without proper grounding facilities, suitable grounding adaptors should be used. Less noise and greatly reduced shock hazard exists when the unit is operated with the proper grounded receptacles.

INSTALLING THE RACK-MOUNT EARS

This unit can be rack-mounted with optional rack-mount kit. To attach the rack-mount ears, simply remove the three screws already in the front on either side of unit and align the ears with the rack-mount flange forward of the unit. Replace the screws and tighten securely, being careful not to overtighten. The unit then mounts in a standard 2 space 19" rack. You may find it desirable to remove the rubber feet from the bottom of the unit in rack-mount installations. The rack-mount ears may also be used to secure the unit in a shelf application to deter theft.

RACK-MOUNT RECOMMENDATION

To provide adequate ventilation, leave at least one rack space between units when multiple amplifiers are mounted in the same rack.

WIRING DIAGRAMS

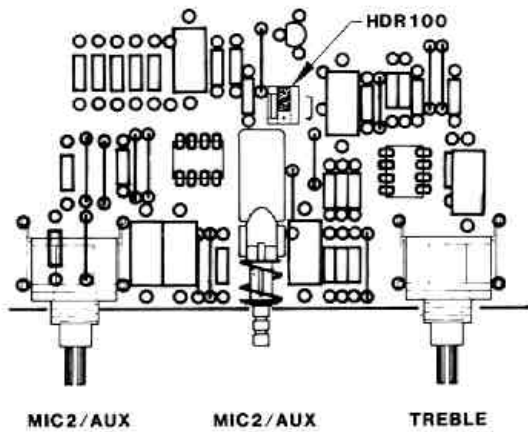

Figure 3

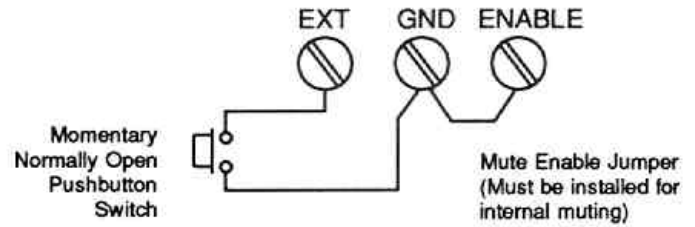

Figure 4

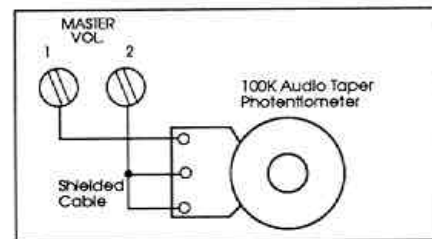

Figure 5

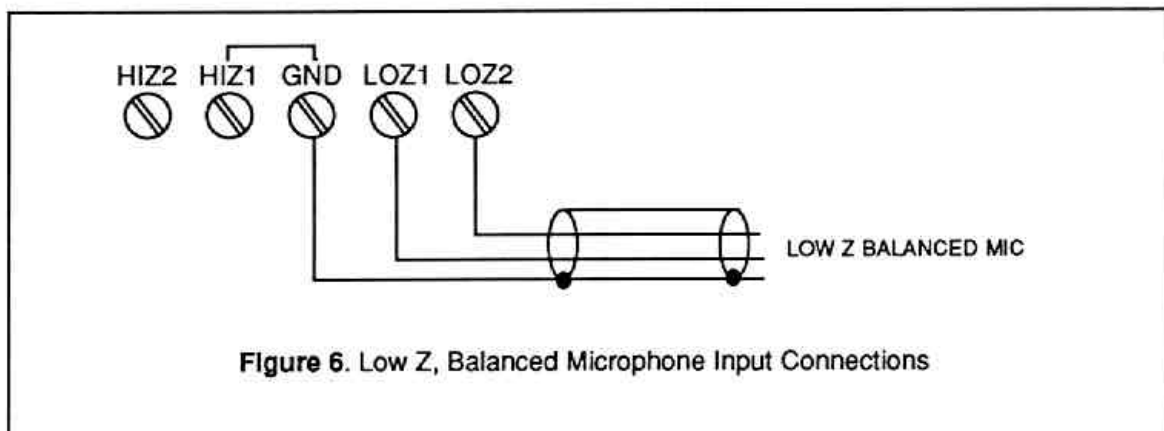

Figure 6. Low Z, Balanced Microphone Input Connections



Figure 7. High Z, Unbalanced Microphone Input Connections

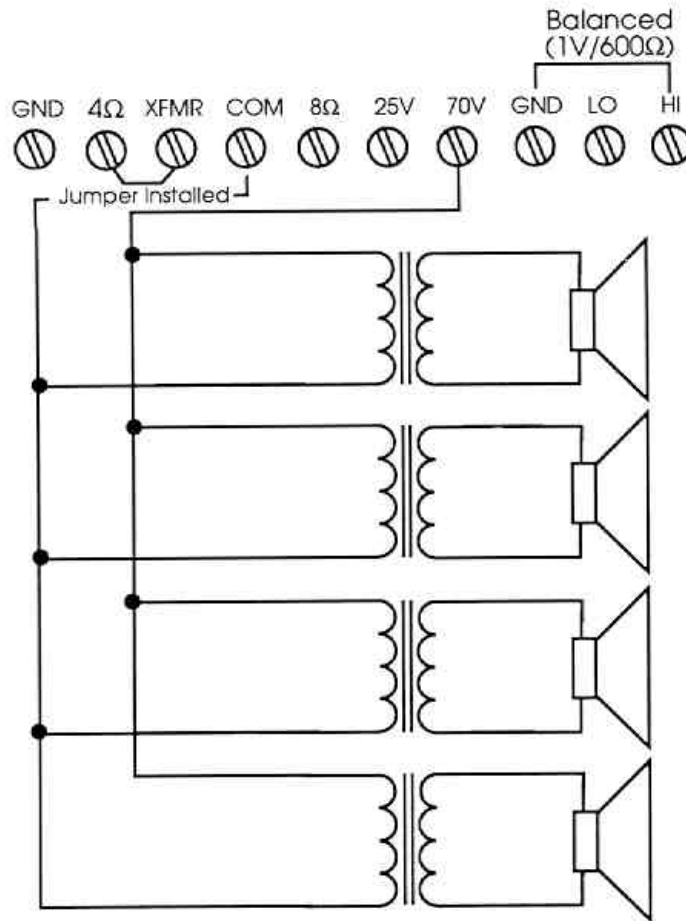

Figure 8: 70V "Constant Voltage" Distribution System

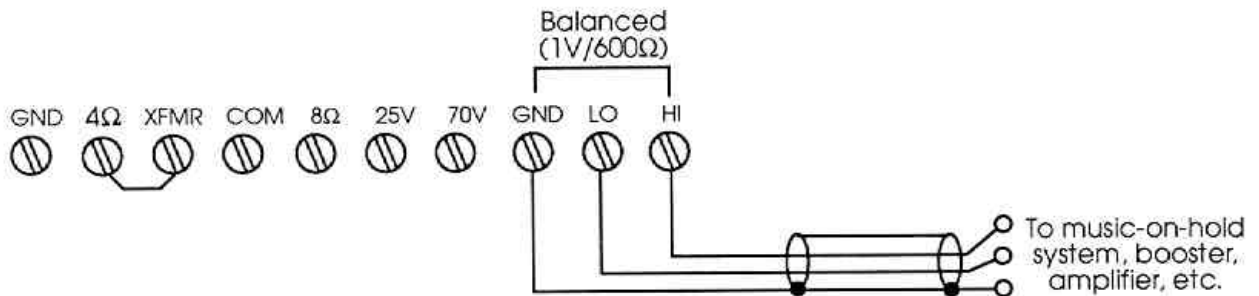
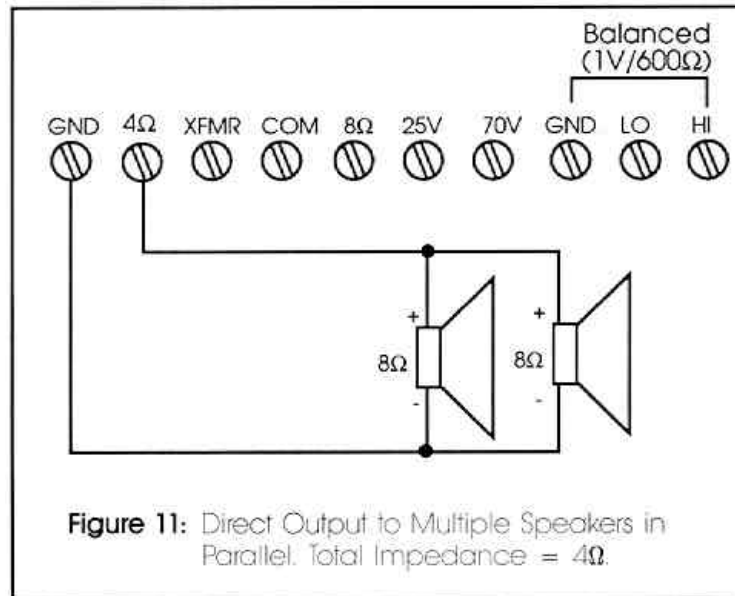
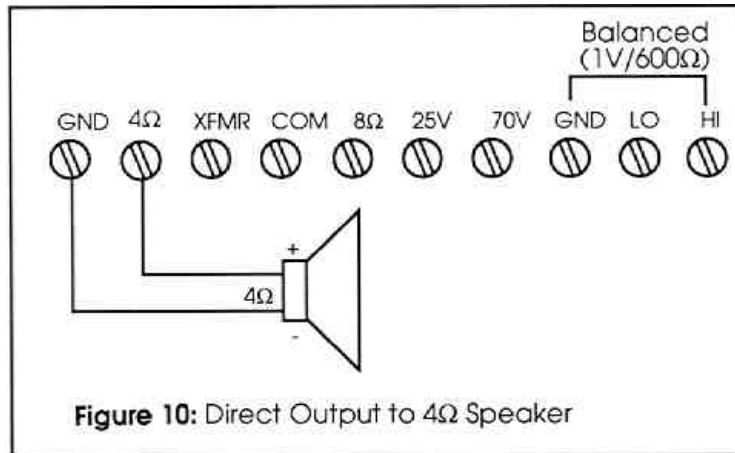
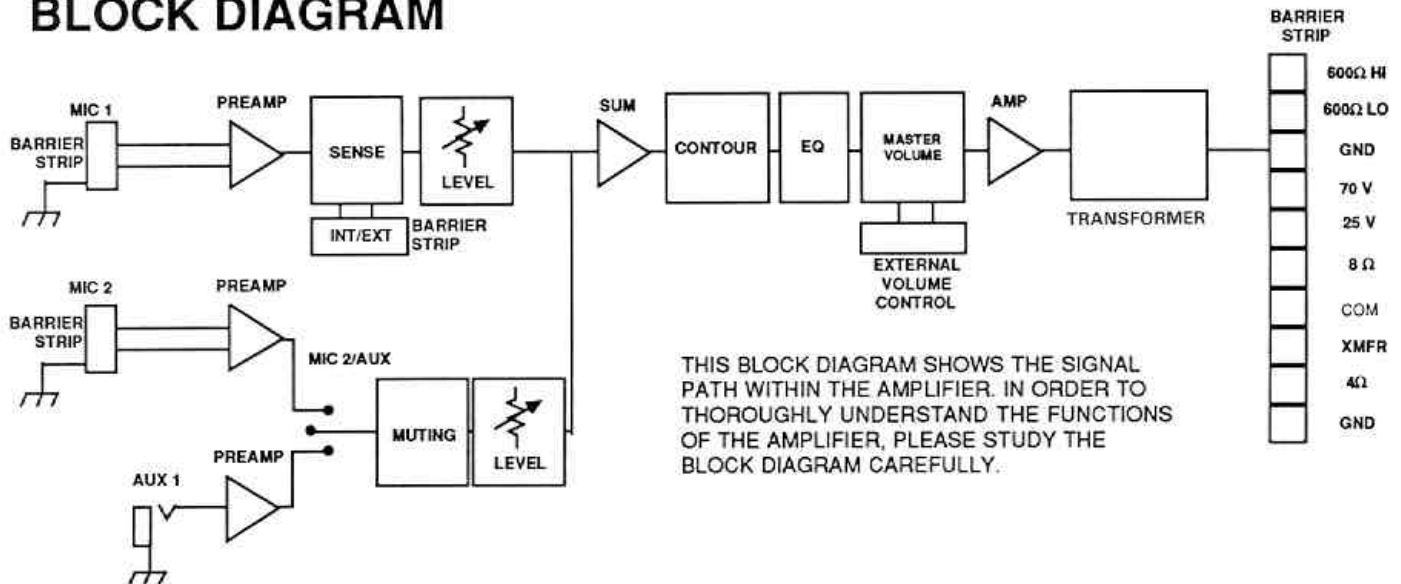

Figure 9: 1 V Balanced Output Connectors



BLOCK DIAGRAM



THIS BLOCK DIAGRAM SHOWS THE SIGNAL PATH WITHIN THE AMPLIFIER. IN ORDER TO THOROUGHLY UNDERSTAND THE FUNCTIONS OF THE AMPLIFIER, PLEASE STUDY THE BLOCK DIAGRAM CAREFULLY.

UMA 12T ARCHITECTURAL AND ENGINEERING SPECIFICATIONS:

The mixer amplifier shall have one dedicated microphone channel and one switchable microphone/auxiliary channel. Each microphone channel shall feature one low impedance balanced input and one high impedance input. The master section shall include one EQ control providing 10 dB boost or cut at 100 Hz and 10 kHz and a "Contour" switch providing 10 dB boost at 100 Hz and 6 dB boost at 10 kHz. The unit shall provide selectable automatic muting of the MIC 2/AUX channel with precedence given to the MIC 1 channel. Connections for external mute shall be provided through barrier strip connections on the back panel. Provision for an external master volume control shall be made via barrier strip connections on the back panel. The unit shall be packaged in a rugged metal chassis 12" wide by 3½" high by 9½" deep (including external heatsinks). The unit shall operate from standard 120 volts AC, 60 Hz power. The internal power amplifier shall be capable of delivering 12 watts into 4 ohms, and 8 ohms, as well as providing 25 volt and 70 volt line outputs. The unit shall be capable of delivering rated power from 50 Hz to 18 kHz ± 1.5 dB into 4 ohms at its direct output at 1% or less distortion with system hum and noise at least 80 dB below rated output from line level AUX input (0.2% distortion @ 10 watts.) The unit shall be called the Peavey Architectural Acoustics Division model UMA™ 12T.

SPECIFICATIONS

POWER AMPLIFIER SECTION

Rated Power and Load:

Direct Output: 12W RMS @ 4 ohms

Fully Isolated Transformer Output: 12W RMS @ 52 ohms (25V)/417 ohms (70V)

Distortion:

Less than 1% @ 12 watts

0.2% THD @ 10 watts

Frequency Response:

Direct Output: ± 1.5 dB

50 Hz to 18 kHz

PREAMPLIFIER SECTION

Input Sensitivity:

High Z MIC: 5 mV

Low Z MIC: 500 mV

AUX: 150 mV

Equalization:

Tone control: ± 10 dB @ 10 kHz

Contour Circuit

System Hum and Noise At Nominal Level:

80 dB below rated power from line level AUX input

DANGER

EXPOSURE TO EXTREMELY HIGH NOISE LEVELS MAY CAUSE A PERMANENT HEARING LOSS. INDIVIDUALS VARY CONSIDERABLY IN SUSCEPTIBILITY TO NOISE INDUCED HEARING LOSS, BUT NEARLY EVERYONE WILL LOSE SOME HEARING IF EXPOSED TO SUFFICIENTLY INTENSE NOISE FOR A SUFFICIENT TIME. THE U.S. GOVERNMENT'S OCCUPATIONAL SAFETY AND HEALTH ADMINISTRATION (OSHA) HAS SPECIFIED THE FOLLOWING PERMISSIBLE NOISE LEVEL EXPOSURES:

DURATION PER DAY IN HOURS	SOUND LEVEL DBA, SLOW RESPONSE
8	90
6	92
4	95
3	97
2	100
1 1/2	102
1	105
1/2	110
1/4 or less	115

ACCORDING TO OSHA, ANY EXPOSURE IN EXCESS OF THE ABOVE PERMISSIBLE LIMITS COULD RESULT IN SOME HEARING LOSS. EAR PLUGS OR PROTECTORS IN THE EAR CANALS OR OVER THE EARS MUST BE WORN WHEN OPERATING THIS AMPLIFICATION SYSTEM IN ORDER TO PREVENT A PERMANENT HEARING LOSS IF EXPOSURE IS IN EXCESS OF THE LIMITS AS SET FORTH ABOVE. TO INSURE AGAINST POTENTIALLY DANGEROUS EXPOSURE TO HIGH SOUND PRESSURE LEVELS, IT IS RECOMMENDED THAT ALL PERSONS EXPOSED TO EQUIPMENT CAPABLE OF PRODUCING HIGH SOUND PRESSURE LEVELS SUCH AS THIS AMPLIFICATION SYSTEM BE PROTECTED BY HEARING PROTECTORS WHILE THE UNIT IS IN OPERATION.

CAUTION

THIS AMPLIFIER HAS BEEN DESIGNED AND CONSTRUCTED TO PROVIDE ADEQUATE POWER RESERVE FOR PLAYING MODERN MUSIC WHICH MAY REQUIRE OCCASIONAL PEAK POWER. TO HANDLE OCCASIONAL PEAK POWER, ADEQUATE POWER "HEADROOM" HAS BEEN DESIGNED INTO THIS SYSTEM. EXTENDED OPERATION AT ABSOLUTE MAXIMUM POWER LEVELS IS NOT RECOMMENDED SINCE THIS COULD DAMAGE THE ASSOCIATED LOUDSPEAKER SYSTEM. PLEASE BE AWARE THAT **MAXIMUM POWER** CAN BE OBTAINED WITH VERY LOW SETTINGS OF THE GAIN CONTROLS IF THE INPUT SIGNAL IS VERY STRONG.

1. Read all safety and operating instructions before using this product.
2. All safety and operating instructions should be retained for future reference.
3. Obey all cautions in the operating instructions and on the back of the unit.
4. All operating instructions should be followed.
5. This product should not be used near water, i.e. a bathtub, sink, swimming pool, wet basement, etc.
6. This product should be located so that its position does not interfere with its proper ventilation. It should not be placed flat against a wall or placed in a built-in enclosure that will impede the flow of cooling air.
7. This product should not be placed near a source of heat such as a stove, radiator or another heat producing amplifier.
8. Connect only to a power supply of the type marked on the unit adjacent to the power supply cord.
9. Never break off the ground pin on the power supply cord. For more information on grounding write for our free booklet "Shock Hazard and Grounding."
10. Power supply cords should always be handled carefully. Never walk or place equipment on power supply cords. Periodically check cords for cuts or signs of stress, especially at the plug and the point where the cord exits the unit.
11. The power supply cord should be unplugged when the unit is to be unused for long periods of time.
12. If this product is to be mounted in an equipment rack, rear support should be provided.
13. Metal parts can be cleaned with a damp rag. The vinyl covering used on some units can be cleaned with a damp rag, or an ammonia based household cleaner if necessary.
14. Care should be taken so that objects do not fall and liquids are not spilled into the unit through the ventilation holes or any other openings.
15. This unit should be checked by a qualified service technician if:
 - A. The power supply cord or plug has been damaged.
 - B. Anything has fallen or been spilled into the unit.
 - C. The unit does not operate correctly.
 - D. The unit has been dropped or the enclosure damaged.
16. The user should not attempt to service this equipment. All service work should be done by a qualified service technician.

LIMITED WARRANTY

Peavey Electronics Corporation warrants to the original purchaser of this new Architectural Acoustics product that it is free from defects in material and workmanship. If within one (1) year from date of purchase a properly installed product proves to be defective and Peavey is notified, Peavey will repair or replace it at no charge. (Note: Batteries and patch cords not covered.) "Original purchaser" means the customer for whom the product is originally installed.

Damage resulting from improper installation, interconnection of a unit or system of another manufacturer, accident or unreasonable use, neglect or any other cause not arising from defects in material and workmanship is not covered by this warranty. The warranty is valid only as to products purchased and installed in the United States.

THIS LIMITED WARRANTY IS IN LIEU OF ANY AND ALL WARRANTIES, EXPRESSED OR IMPLIED, INCLUDING THE IMPLIED WARRANTIES OF MERCHANTABILITY AND FITNESS FOR A PARTICULAR USE. UNDER NO CIRCUMSTANCES WILL PEAVEY BE LIABLE FOR ANY LOST PROFITS, LOST SAVINGS, INCIDENTAL DAMAGES OR CONSEQUENTIAL DAMAGES ARISING OUT OF THE USE OR INABILITY TO USE THE PRODUCT, EVEN IF PEAVEY HAS BEEN ADVISED OF THE POSSIBILITY OF SUCH DAMAGE. THIS LIMITED WARRANTY IS THE ONLY EXPRESSED WARRANTY ON THIS PRODUCT, AND NO OTHER STATEMENT, REPRESENTATION, WARRANTY, OR AGREEMENT BY ANY PERSON SHALL BE VALID OR BINDING UPON PEAVEY.

Peavey's liability to the original purchaser for damages for any cause whatsoever and regardless of the form of action, is limited to the actual damages up to the greater of Five Hundred Dollars (\$500) or an amount equal to the purchase price of the product that caused the damage or that is the subject of or is directly related to the cause of action. This limitation of liability will not apply to claims for personal injury or damage to real property or tangible personal property allegedly caused by Peavey's negligence. For information on service under this warranty, call a Peavey customer service representative at (601) 483-5376.



Features and specifications subject to change without notice.

A Division of Peavey Electronics Corporation

711 A Street, P. O. Box 2898, Meridian, MS 39302-2898 / (601) 483-5376 / Telex 504115 / Fax (601) 484-4278