

SPECIFICATIONS

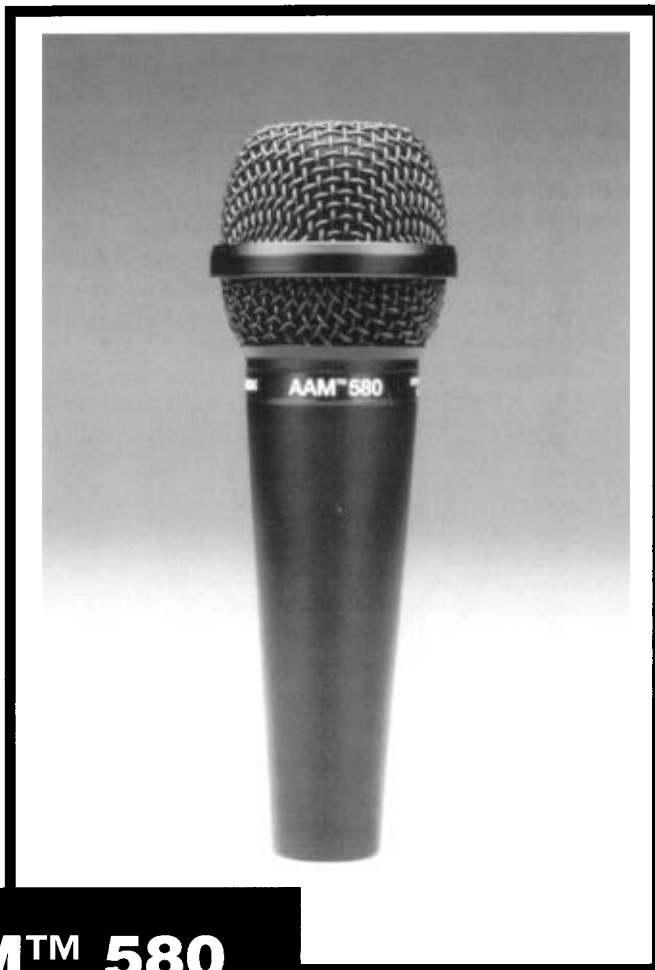

AAM™ 580 Unidirectional Hypercardioid Dynamic Microphone

SPECIFICATIONS

Enclosure:
AAM™ 580

Element Type:
Dynamic

Magnet Composition:
Neodymium Iron Boron

Polar Pattern:
Hypercardioid

Front-to-Back Rejection:
20 dB (typical)

Impedance:
Low (300 ohms, balanced)

Windscreen:

Brazed steel mesh

Sensitivity:

Output Power Level:
-52 dB (0 dB = 1 mW/10 microbar*)

Open Circuit Voltage:
-68 dB (0 dB = 1 volt/dyne/cm²)

Pop Filter:

Dual Integral, open cell foam

External Windscreen:

80 ppi open cell foam

Connector:

3-pin XLR type

Phasing:

Positive (inward) pressure on diaphragm produces positive pulse at pin #2.

Weight:

14 oz. (400 grams)

Furnished Accessories:

Carrying case, swivel adaptor, foam windscreen, and 25' (7.62 m) balanced low impedance cable with 3-pin and 3-socket XLR equivalent audio connectors.

*10 microbars = 1 pascal = 10 dynes/cm²

FEATURES

- Ultra high sensitivity
- Neo-Dynamic™ design
- Tandem tuned electromechanical rumble filter dramatically reduces handling noise and mic stand clicks
- Hypercardioid polar response
- Titanium laminate diaphragm
- Warm vocal response
- Neodymium magnetics
- Superior off-axis rejection
- Superb feedback rejection

DESCRIPTION

The AAM™ 580 Neo-Dynamic™ microphone is a unidirectional, hypercardioid, dynamic microphone that relies on the latest technologies in rare earth magnets, component design, and finishing.

The AAM 580 incorporates a new shockmount system that utilizes a tandem tuned mechanical and electrical filter to reduce handling noise. The mechanical filter is tuned to resonate at frequencies well below the operating range of the microphone, allowing an electrical circuit to be employed to filter the mechanical signals produced while handling the microphone. The two tuned circuits give the microphone virtual silence while moving it around.

The rumble filter is designed using a specialized, high-quality transformer allowing it to work without degradation to the low frequency signals while maintaining true balanced, low impedance operation. Handling noise is virtually a thing of the past.

Next, a tougher finish and new feel are accomplished using the latest in material and coating technology. The machined, ultra-fine finished black alloy handle is hard coated. This coating process allows for accurate color control and the use of an alloy that makes for a lightweight feel in a durable package. This process gives the microphone a finish that is literally part of the metal making it scratch resistant.

PEAVEY
ARCHITECTURAL ACOUSTICS®

The finish is designed to keep the microphone looking as well as it performs through the years.

A neodymium iron boron magnet is the heart of the high output unit. The rare earth magnet allows for output expected only from condenser type microphones—but without the use of batteries or external power supplies.

The AAM 580 delivers a warm vocal response that can be worked to cut through the high level stage environments. The hypercardioid response allows the AAM 580 to be used in high feedback environments and also makes it a great choice for instrument micing on stage.

The internal pop filter has been redesigned to give excellent protection against plosive sounds such as "th" and "p." An external windscreen is supplied for cases where extreme wind conditions exist.

The unit comes in a durable, hard

shell case and is supplied with a premium quality 25' low impedance XLR type cable.

PROXIMITY

Proximity effect is a naturally occurring phenomenon in unidirectional microphones. The effect is to accentuate or boost the low frequency response. This effect is a function of distance from the diaphragm to the source and increases as the diaphragm is moved closer to the source.

ACCESSORIES

Durable flight-type carrying case, swivel adaptor, foam windscreen, and 25' (7.62 m) balanced low impedance cable with 3-pin XLR equivalent audio connectors.

ARCHITECTURAL & ENGINEERING SPECIFICATIONS

The microphone shall be a moving coil dynamic type. The microphone shall have a hypercardioid polar characteristic with a rear response that is 15 to 20 dB down. The microphone shall have an output power level of -52 dBm where 0 dB = 1 mW/10 microbar and a nominal impedance of 300 ohms.

The connector shall be a 3-pin XLR equivalent audio type, and a swivel adaptor shall be provided to mount on a stand having 5/8" in length and 1-7/8" in diameter.

The microphone shall be a Peavey Architectural Acoustics Division model AAM 580 Neo-Dynamic™ or equivalent.

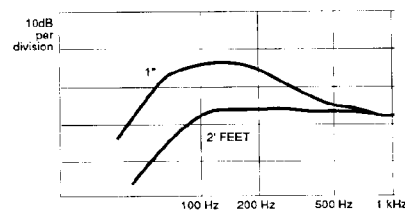
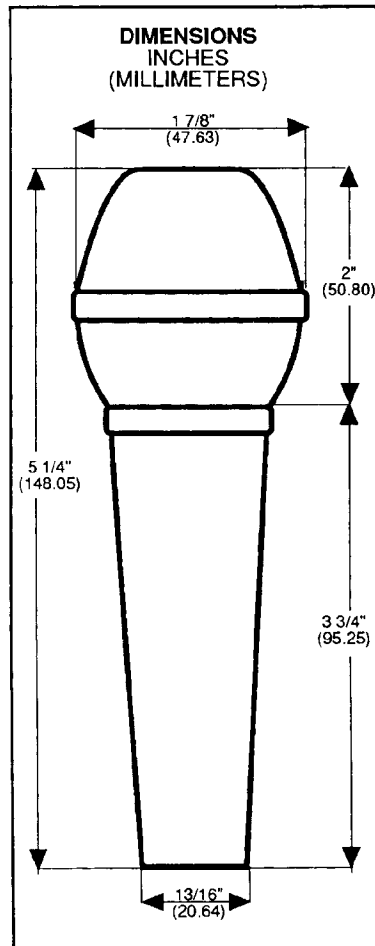

FREQUENCY RESPONSE
PROXIMITY EFFECT

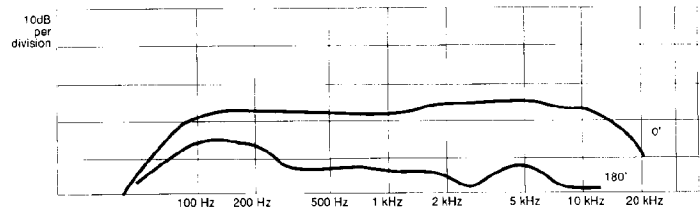

0° & 180° FREQUENCY RESPONSE

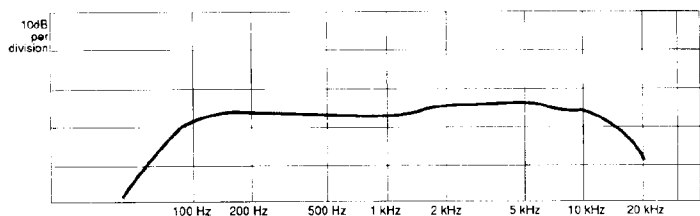

FREQUENCY RESPONSE

POLAR PATTERNS

10dB
per
division

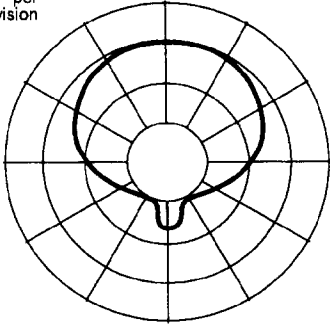

500Hz

10dB
per
division

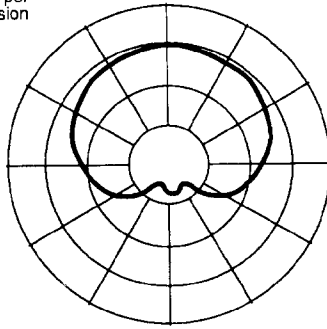

1K

10dB
per
division

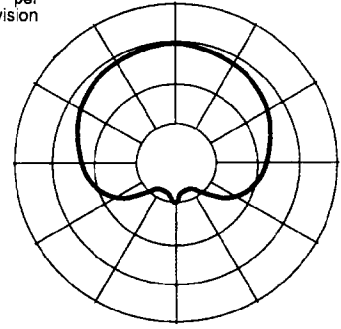

2K

10dB
per
division

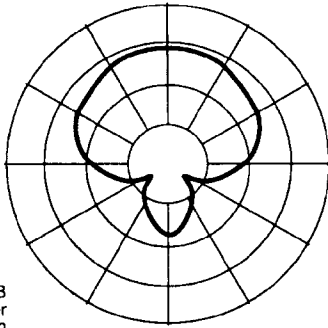

5K

10dB
per
division

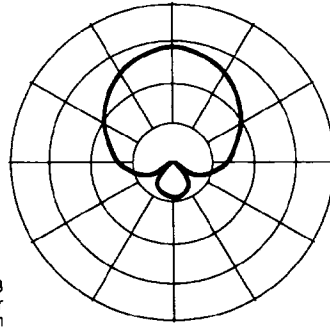

10K

WIRING DIAGRAM

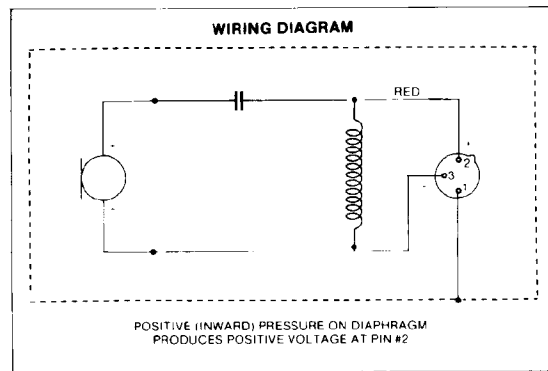

PEAVEY MICROPHONE LIMITED WARRANTY/REMEDY

PEAVEY ELECTRONICS CORPORATION ("Peavey") warrants this microphone to the original retail purchaser to be free from defects in material and workmanship for a period of one (1) year from date of purchase; provided, however, that the existence of this limited warranty is subject to the conditions, exclusions and limitations hereinafter set forth.

In case of a covered defect in material or workmanship, Peavey will repair or replace the microphone, at Peavey's option, provided that consumer:

(a) brings the defective microphone to any Peavey Authorized Dealer or Service Center and presents therewith a copy of the sales receipt or other proof of purchase. If the DEALER or SERVICE CENTER is unable to provide the necessary warranty service, the consumer will be directed to the nearest other PEAVEY AUTHORIZED DEALER or SERVICE CENTER which can provide such service; or

(b) returns the defective microphone, shipping charges prepaid, to Peavey Electronics Corporation, 326 Hwy. 11 & 80 East, Meridian, Mississippi, and includes therewith a written description of the problem, a copy of the sales receipt or other proof of purchase and consumer's complete return address.

If the defect is remedial under this limited warranty and the other terms and conditions expressed herein have been complied with, Peavey will provide the necessary warranty service to repair or replace the microphone and will return it, freight collect, to the consumer.

Under no circumstances will Peavey be liable for any lost profits, lost savings or other consequential or incidental damages arising out of the use or inability to use the product, even if Peavey had been advised of the possibility of such damage.

THIS LIMITED WARRANTY IS IN LIEU OF ANY AND ALL WARRANTIES, EXPRESSED OR IMPLIED, INCLUDING, BUT NOT LIMITED TO, THE IMPLIED WARRANTIES OF MERCHANTABILITY AND FITNESS FOR PARTICULAR USE; provided, however, that upon compliance with the other terms and conditions necessary to the existence of the express limited warranty, such implied warranties are not disclaimed during the applicable one year period from date of purchase of this product.

SOME STATES DO NOT ALLOW LIMITATIONS ON HOW LONG AN IMPLIED WARRANTY LASTS OR THE EXCLUSION OR LIMITATION OF INCIDENTAL OR CONSEQUENTIAL DAMAGES, SO THE ABOVE LIMITATIONS OR EXCLUSIONS MAY NOT APPLY TO YOU, THIS LIMITED WARRANTY GIVES YOU SPECIFIC LEGAL RIGHTS, AND YOU MAY ALSO HAVE OTHER RIGHTS WHICH MAY VARY FROM STATE TO STATE.

In the event any modification or disclaimer of express or implied warranties or any limitation of remedies contained herein conflicts with applicable law, then such modification, disclaimer or limitation as the case may be, shall be deemed to be modified to the extent necessary to comply with such law.

Peavey Electronics Corporation gives this limited warranty only with respect to Peavey microphones purchased in the United States of America. This limited warranty shall be void and of no effect if:

- (a) first purchase of the product is for the purpose of resale; or
- (b) the original retail purchase is not made from an AUTHORIZED PEAVEY DEALER; or
- (c) the product has been damaged by accident or unreasonable use, neglect, improper service or maintenance, or other causes not arising out of defects in material or workmanship.



Features and specifications subject to change without notice.

Peavey Electronics Corporation 711 A Street / Meridian, MS 39301 / U.S.A. / (601) 483-5365 / Fax: 486-1278